

# ~ Schale Kaskadenbrunnen I ~

Contents / Inhalt / Contenu / Inhoud:

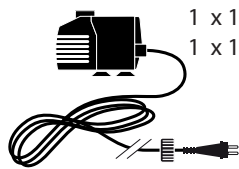

1 x 1409956 EU  
1 x 1409954 UK

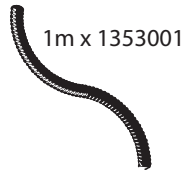

1m x 1353001



1 x 1409851 EU  
1 x 1409551 UK



3 x 1003152

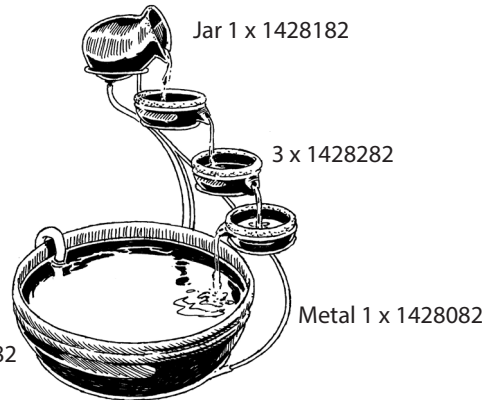

Jar 1 x 1428182

3 x 1428282

1 x 1428382

Metal 1 x 1428082

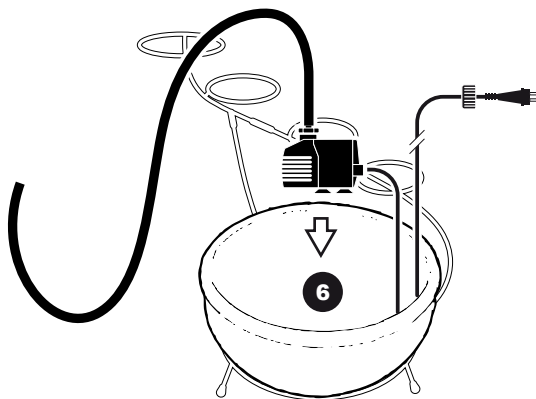
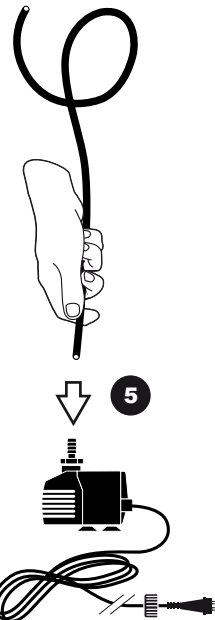
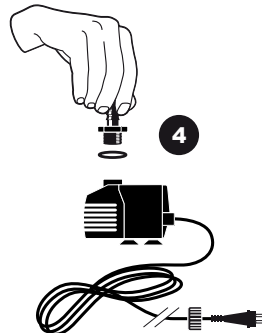
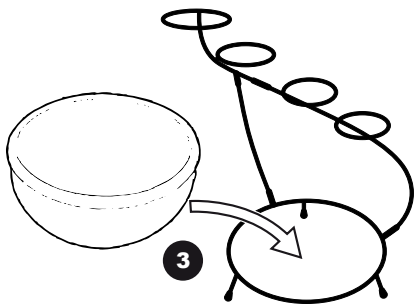
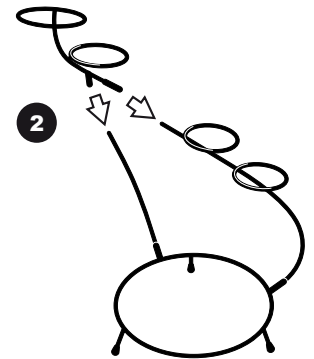
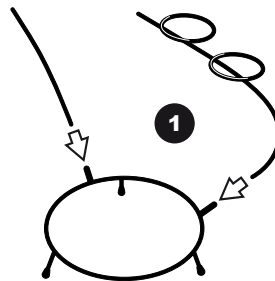
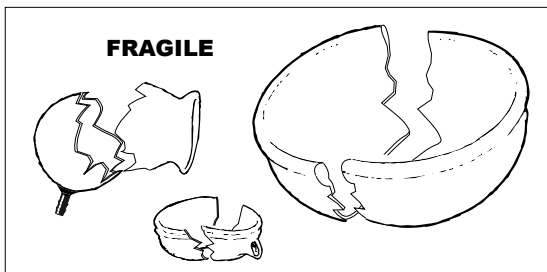

# ~ Schale Kaskadenbrunnen I ~

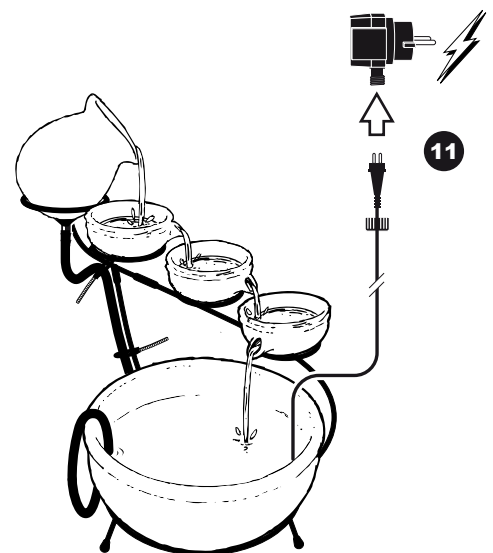
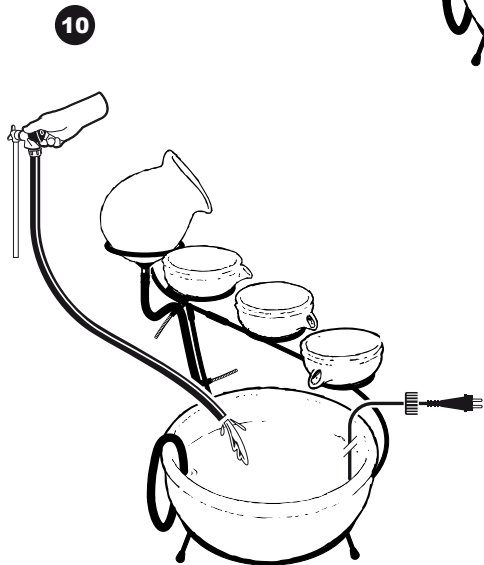
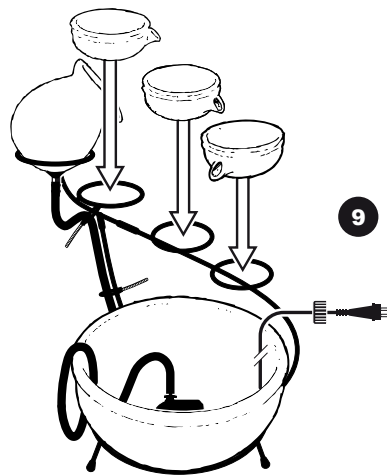
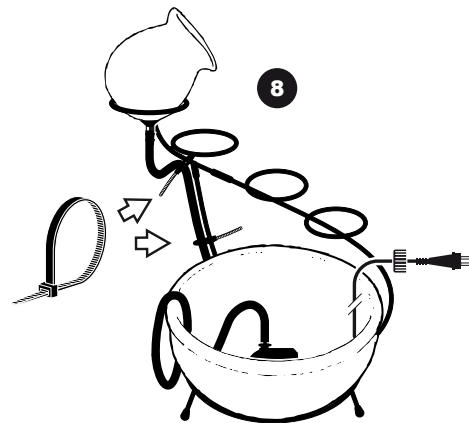
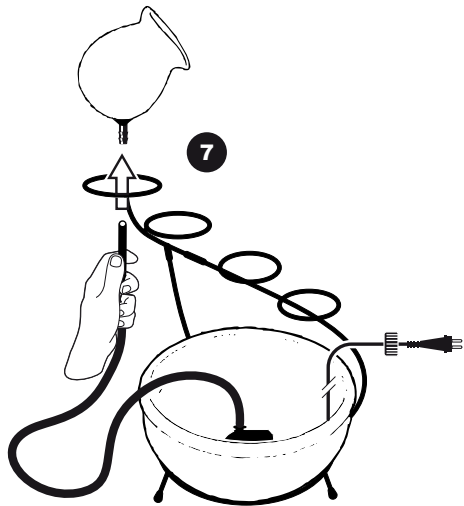

- During severe frost switch off the pump, remove ornament and pump!
- Bei strengem Frost sollte das Set ausgeschaltet sowie das Deko-Element und Pumpe entfernt werden!
- Tijdens strenge vorst set uitschakelen, ornament en pomp verwijderen!
- Protégez votre fontaine décorative et mettez votre pompe à l'arrêt pendant la période d'hiver.